



**TOLL FREE 1-800-392-0146**

[www.hoist-parts.com](http://www.hoist-parts.com)  
[parts@sisscohoist.com](mailto:parts@sisscohoist.com)

**SISSCO ONLINE HOIST PARTS DISTRIBUTION CENTER MANUALS**



***A Reputation for Service Since 1972***  
***Certified WBE***



**OPERATING,  
MAINTENANCE &  
PARTS MANUAL**

---

**MANUALLY LEVER  
OPERATED  
CHAIN HOIST**

**CM<sup>®</sup>  
SERIES**



**637**

Before installing hoist, fill in the information below.

Rated Load \_\_\_\_\_

Serial No. \_\_\_\_\_

Purchase Date \_\_\_\_\_

**Rated Loads:**  
3/4, 1-1/2, 3, 6 tons  
(750, 1500, 3000 and  
6000kg.)

**Follow all instructions and warnings for inspecting, maintaining and operating this hoist.** The use of any hoist presents some risk of personal injury or property damage. That risk is greatly increased if proper instructions and warnings are not followed. Before using this hoist, each operator should become thoroughly familiar with all warnings, instructions and recommendations in this manual. **Retain this manual for future reference and use.**

**Forward this manual to operator.** Failure to operate equipment as directed in manual may cause injury.

**CM HOIST PARTS AND SERVICES ARE AVAILABLE  
IN THE UNITED STATES AND IN CANADA**

As a CM Hoist user, you are assured of reliable repair and parts services through a network of Master Parts Depots and Service Centers that are strategically located in the United States and Canada. These facilities have been selected on the basis of their demonstrated ability to handle all parts and repair requirements promptly and efficiently. To quickly obtain the name of the Master Parts Depot or Service Center located nearest you, call (800) 888-0985. Fax: (716) 689-5644.

# SAFETY PRECAUTIONS

Each CM Series 637 Lever Operated Hoist is built in accordance with the specifications contained herein and at the time of manufacture complies with our interpretation of applicable sections of the \* American Society of Mechanical Engineers Code B30.21 "Manually Operated Lever Hoists".

The safety laws for elevators and for dumbwaiters may specify construction details that are not necessarily incorporated in CM industrial hoists. We recommend the use of equipment that meets state and national safety codes. Columbus McKinnon Corporation cannot be responsible for applications other than those for which CM equipment is recommended.



THIS SYMBOL POINTS OUT IMPORTANT SAFETY INSTRUCTIONS WHICH IF NOT FOLLOWED COULD ENDANGER THE PERSONAL SAFETY AND/OR PROPERTY OF YOURSELF AND OTHERS. READ AND FOLLOW ALL INSTRUCTIONS IN THIS MANUAL AND ANY PROVIDED WITH THE EQUIPMENT BEFORE ATTEMPTING TO OPERATE YOUR CM SERIES 637 LEVER HOIST.



\*Copies of this standard can be obtained from ASME Order Department, 22 Law Drive, Box 2300, Fairfield, NJ 07007-2300, U.S.A.

## DO'S AND DO NOT'S

### Safe Operation of Hoists

The following are Do's and Do Not's for safe operation of Hoists. Taking precedence over any specific rule listed here, however, is the most important rule of all, USE COMMON SENSE. A few minutes spent reading these rules can make an operator aware of dangerous practices to avoid and precautions to take for his own safety and the safety of others. Frequent examinations and periodic inspections of the equipment as well as a conscientious observance of safety rules may save lives as well as time and money.

1. **DO** read ASME B30.21, HST-3M and this Manual thoroughly.
2. **DO** be familiar with the Hoist operating controls, procedures and warnings.
3. **DO** make sure the suspension hook is securely attached to a suitable support.
4. **DO** maintain firm footing or be otherwise secure when operating the Hoist.
5. **DO** make sure that load slings or other approved single attachments are properly sized and seated in the hook saddle.
6. **DO** make sure that the hook latch, if used, is closed and not supporting any part of the load.
7. **DO** make sure that the load is free to move and will clear all obstructions.
8. **DO** take up slack carefully, check load balance, lift a few inches and check load holding action before continuing.
9. **DO** make sure that all persons stay clear of the suspended load.
10. **DO** avoid swinging of load or load hook.
11. **DO** protect load chain from weld spatter or other damaging contaminants.
12. **DO** promptly report any malfunction, unusual performance, or damage of the Hoist.
13. **DO** inspect the Hoist regularly, replace damaged or worn parts, and keep appropriate records of maintenance.
14. **DO** use CM Replacement Parts when repairing a Series 637 Lever Operated Hoist.
15. **DO** use hook latches.
16. **DO** apply lubricant to the load chain as recommended in this manual.
17. **DO NOT** apply more than rated load.
18. **DO NOT** use an extension on the lever.
19. **DO NOT** use damaged Hoist or Hoist that is not working correctly.
20. **DO NOT** use the Hoist with twisted, kinked, damaged or worn chain.
21. **DO NOT** apply a load unless chain is properly seated in chain wheel(s) or sprocket(s).
22. **DO NOT** use load chain as a sling or wrap chain around the load.
23. **DO NOT** apply a load if any binding prevents equal loading on all supporting chains.
24. **DO NOT** apply the load to the tip of the hook.
25. **DO NOT** operate the Series 637 Lever Operated Hoist with other than manual power.
26. **DO NOT** permit more than one operator to pull on the lever at one time.
27. **DO NOT** allow your attention to be diverted from operating the Hoist.
28. **DO NOT** operate the Hoist beyond limits of load chain travel.
29. **DO NOT** use the Series 637 Lever Operated Hoist to lift, support or transport people.
30. **DO NOT** lift loads over people.
31. **DO NOT** leave an applied load unattended unless specific precautions have been taken.
32. **DO NOT** allow sharp contact between two Hoists or between the Hoist and obstructions.
33. **DO NOT** allow the chain or hook to be used as a ground for welding.
34. **DO NOT** allow the chain or hook to be touched by a live welding electrode.
35. **DO NOT** remove or obscure the warnings on the Hoist.
36. **DO NOT** adjust or repair a Hoist unless qualified to perform such maintenance.
37. **DO NOT** attempt to lengthen the load chain or repair damaged load chain.

# Hoist Safety is up to you...

**⚠ WARNING** - DO NOT APPLY MORE THAN RATED LOAD.

## 1 CHOOSE THE RIGHT HOIST FOR THE JOB...

Choose a hoist with the capacity for the job. Know the capacities of your hoists and the weight of your loads. Then match them.

The application, the size and type of load, the attachments to be used and the period of use must also be taken into consideration in selecting the right hoist for the job.



Remember the Series 637 Lever Hoist was designed to ease our burden and carelessness not only endangers the operator, but in many cases, a valuable load.

**⚠ WARNING** - DO NOT OPERATE DAMAGED OR MALFUNCTIONING UNIT  
 - DO NOT OPERATE WITH TWISTED, KINKED OR DAMAGED CHAIN  
 - DO NOT PULL ON OR TURN FREE CHAINING KNOB IF HOIST IS LOADED.

## 2 INSPECT

All hoists should be visually inspected before use, in addition to regular, periodic maintenance inspections.

Inspect hoists for operations warning notices and legibility.

Deficiencies should be noted and brought to the attention of supervisors. Be sure defective hoists are tagged and taken out of service until repairs are made.



Under no circumstances should you operate a malfunctioning hoist.

Check for gouged, twisted, distorted links and foreign material. Do not operate Hoists with twisted, kinked or damaged chain links.

Load chain should be properly



lubricated.

Hooks that are bent, worn or whose openings are enlarged beyond normal throat opening should not be used. If latch does not engage throat opening of hook, hoist should be taken out of service.



Check brake for evidence of slippage under load. Do not pull on or turn Free Chaining Knob if hoist is loaded. Load will release.

**⚠ WARNING** - DO NOT PULL AT AN ANGLE. BE SURE HOIST AND LOAD ARE IN A STRAIGHT LINE.  
 - DO NOT USE UNLESS FRAME AND CHAIN FORM A STRAIGHT LINE BETWEEN HOOKS.  
 - DO NOT USE IF FRAME IS IN CONTACT WITH ANY OBJECT.  
 - DO NOT USE LOAD CHAIN AS A SLING.  
 - DO NOT USE AN EXTENSION ON THE LEVER.

## 3 USE HOIST PROPERLY

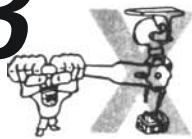

Be sure the hoist is solidly held in the uppermost part of the support hook arc.



Be sure hoist and load are in a straight line. Do not use unless frame and chain form a straight line between hooks.



Be sure load is hooked securely. Do not tip load the hook. Do not load hook latch. Hook latch is to prevent detachment of load under slack chain conditions only.



Do not operate with frame resting against any object. Apply the load gently. Do not jerk it.



Never use an extension on the lever! You're dangerously overloading the hoist if you exceed the rated lever pull or if you have to use a lever extension to lift or pull a load.

**⚠ WARNING** - DO NOT LIFT PEOPLE OR LOADS OVER PEOPLE.

## 4 PRACTICE CAUTION ALWAYS

Do not lift co-workers with a hoist.

Make sure everyone is clear of the load when you apply tension.

Do not remove or obscure operational warning notices.

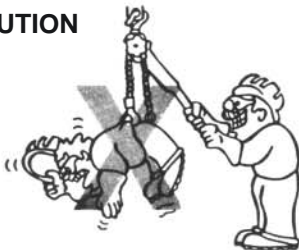

## 5 OPERATOR SERVICE

**CLEANING**  
 Series 637 Lever Hoists should be kept clean and free of dust, dirt, moisture, etc., which will in any way affect the operation or safety of the equipment.

**LUBRICATION**  
 Chain should be properly lubricated.

**AFTER REPAIRS**  
 Carefully operate the hoist before returning it to full service.



**3 VIOLATION OF ANY OF THE WARNING LISTED MAY RESULT IN SERIOUS PERSONAL INJURY TO THE OPERATOR OR NEARBY PERSONNEL BY RELEASED LOAD OR BROKEN HOIST COMPONENTS.**

**CM REPLACEMENT POLICY**

All Columbus McKinnon (CM) Series 637 Lever Hoists are inspected and performance tested prior to shipment. If any properly maintained hoist develops a performance problem within one year of shipment, due to materials or workmanship defect, as verified by CM, repair or replacement of the unit will be made to the original purchaser without charge. This repair/replacement policy applies only to Series 637 Lever Hoists installed, maintained and operated as outlined in this manual, and specifically excludes hoists subject to normal wear, abuse improper installation, improper or inadequate maintenance, hostile environmental effects and unauthorized repairs/modifications.

We reserve the right to change materials or design if, in our opinion, such changes will improve our product. Abuse, repair by an unauthorized person, or use of non-CM replacement parts voids the guarantee and could lead to dangerous operation. For full Terms of Sale, see Sales Order Acknowledgment. Also, refer to the back cover for Limitations of Warranties, Remedies and Damages, and Indemnification and Safe Operation.

**OPERATING INSTRUCTIONS**



**WARNING**

IF NOT USED AS DIRECTED, HOIST MAY CAUSE INJURY.

**TO AVOID INJURY:**  
USE ONLY AS DIRECTED BELOW.

The Series 637 Lever Hoist is designed for operation at nominal ambient temperatures of 0° to 100° F (-18 to 38°c).

Before operating the Series 637 Lever Hoist, familiarize yourself with the nomenclature shown in Figure 1.

1. **Free chaining.** In this mode, the chain can be pulled through the hoist in either direction by hand for quick attachment to the load.

With no load on the hoist, set the directional lever in the neutral ("N") position. Pull the free chaining knob out and rotate counterclockwise until the knob is sitting on top of the cam guide. In this position, the gap between the free chaining knob and the lever will be approximately 5/16" (7.9mm). The internal gearing is now dis-engaged and the chain can be pulled through the hoist in either direction.



**WARNING**

PULLING OUT OR TURNING THE FREE CHAINING KNOB WITH A LOAD ATTACHED WILL ALLOW THE LOAD TO RELEASE AND MAY CAUSE INJURY.

**TO AVOID INJURY:**  
NEVER PULL OR TURN FREE CHAINING KNOB WHEN THE HOIST IS UNDER LOAD.

After the chain has been pulled to the proper length, disengage the free chaining feature by moving directional lever to the "load" position and rotate the free chaining knob in the clockwise direction until the knob engages the cam guide. In this position, the gap between the free chaining knob and the lever will be approximately 1/16" (1.6mm). Pull the load chain in either direction to insure the unit is out of the free chaining mode.

2. **Attachment to the load:** The CM Series 637 Lever Hoist can be used in any position provided it is rigged to pull in a straight line from hook to hook. It is important that the frame is free to swivel on the upper hook.

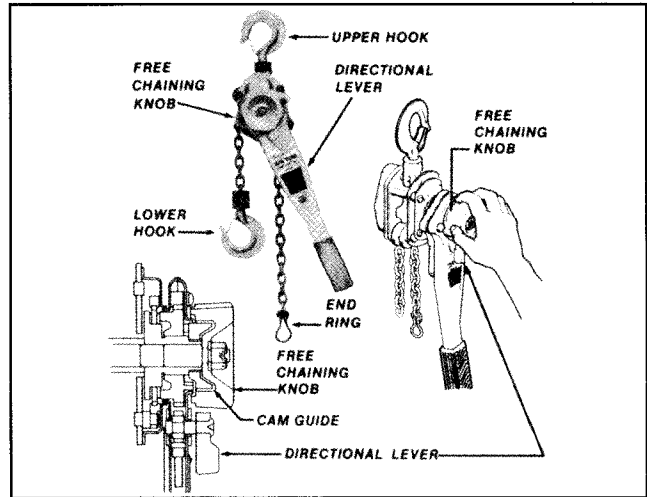

Figure 1. Series 637 Lever Hoist Parts and Free Chaining Operation.



**WARNING**

IF THE UNIT IS NOT RIGGED IN A STRAIGHT LINE HOOK TO HOOK MANNER, AND IF THE FRAME IS NOT FREE TO SWIVEL, LEVEL PULL MAY BREAK FRAME AND CAUSE PHYSICAL INJURY AND LOSS OF LOAD.

**TO AVOID INJURY:**  
RIG THE UNIT IN A STRAIGHT LINE HOOK TO HOOK MANNER AND KEEP FRAME FREE TO SWIVEL - SEE FIGURE 2.

Under no condition should the frame be allowed to touch the load or bear on any support when in use as this might cause bending of the hook or frame and possible failure. Also, make certain the end ring end of the chain feeds into the chain guide roller properly. Twisted chain may become damaged in the liftwheel and may result in chain breakage. When operating in limited areas, it is advised that attachments or slings be used to keep the frame and lever from being obstructed. Refer to Figure 2.

3. **Operation.** (See Hoist Safety is up to you and Safety Procedures): After attachment to the load, take-up the slack chain per the free chaining instructions. Set the

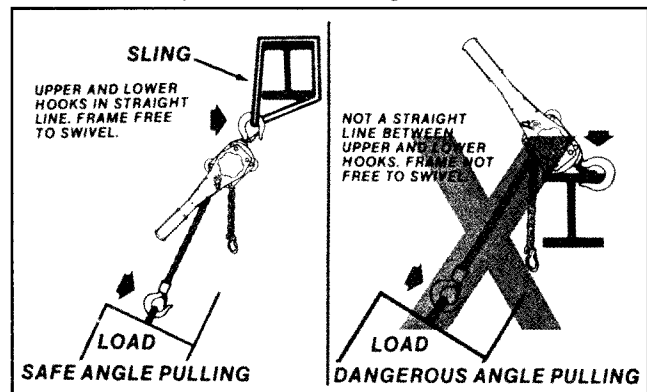



Figure 2. Angle Pulling

directional lever to "load" and operate the lever up and down and the load will be pulled or tensioned. Shift the directional lever to "unload" and the load will be loosened by operating the lever up and down.

 <b>WARNING</b>
Malfunction of unit, rigging slip or loss of footing may cause user to slip resulting in injury.
<b>TO AVOID INJURY:</b>
Always have a firm and secure footing when using the Series 637 Lever Hoist.

**Inspect Hoist** - Before each use and at specified intervals as directed in inspection section.

 <b>WARNING</b>
Use as directed above. Failure to do so may cause injury to you or others.
<ol style="list-style-type: none"> <li>1. <b>Do not</b> exceed capacity shown on the identification plate.</li> <li>2. <b>Do not</b> use to lift people or loads over people.</li> <li>3. <b>Do not</b> use unless the Hoist's frame and chain form a straight line between hooks.</li> <li>4. <b>Do not</b> use if the frame is in contact with any object.</li> <li>5. <b>Do not</b> use if the unit is damaged or malfunctions.</li> <li>6. <b>Do not</b> use extension on lever. Use hand power only.</li> <li>7. <b>Do not</b> use if chain is twisted, kinked or damaged.</li> </ol>

**Safety Procedures**

1. The hoist must be kept clean to assure proper operation. Before use, check to be sure the load chain is clean, that there is no foreign material in the liftwheel area and that the lever operates freely.
2. When preparing to pull or tension a load, be sure the attachment to each hook is firmly seated in the hook saddle. Avoid off-center loading of any kind, especially loading on the tip of the hook.

 <b>WARNING</b>
ALLOWING THE LOAD TO BEAR AGAINST THE HOOK LATCH AND/OR HOOK TIP CAN RESULT IN LOSS OF LOAD.
<b>TO AVOID INJURY:</b>
DO NOT ALLOW THE LOAD TO BEAR AGAINST THE HOOK LATCH AND/OR HOOK TIP. APPLY LOAD TO HOOK BOWL OR SADDLE ONLY.

3. When pulling or tensioning, move the load only enough to slightly load the unit, then check to be sure that the attachments to the hooks and load are firmly seated. Continue movement only after you are assured the load is free of all obstructions.
4. Do not load beyond the rated capacity. Overload can cause immediate failure or cause damage resulting in future failure, even at less than rated capacity.
5. The hoist has been designed for hand powered operation only. Do not use an extension on the lever.

Lever pulls of 35 pounds(15.9Kg.) on the 3/4 ton unit, 40 pounds(18.1Kg.) on the 1-1/2 ton unit, 73 pounds(33.1Kg.) on the 3 ton unit and 77 pounds(34.9Kg.) on the 6 ton unit, will result in rated capacity on the unit. Any greater pull is an indication of either an overload or an incorrectly maintained unit.

 <b>WARNING</b>
POWER OPERATION MAY CAUSE DAMAGE OR PREMATURE WEAR THAT IN TURN MAY CAUSE A PART TO BREAK AND ALLOW THE LOAD TO FALL.
<b>TO AVOID INJURY:</b>
OPERATE THE HOIST USING HAND POWER ONLY!

6. Do not use this hoist or any other material handling equipment for lifting or moving people, or lifting loads over people.
7. Stand clear of all loads and warn other people of your intention to move a load in their area.
8. Do not leave a load on the unit unattended.
9. Do not take up the load chain to the point where the end ring or lower hook block becomes jammed against the frame.
10. Read warnings and instructions on the lever before each use.
11. Do not wrap the load chain around the load and hook onto itself as a choker chain sling or bring the load in contact with the hoist. Doing this will result in the loss of the swivel effect of the hook which could result in twisted chain and a jammed liftwheel. Also, the chain may be damaged at the hook.
12. Do not hold the load chain while operating the hoist. Should the hoist not operate properly, serious injury may occur.
13. Do not operate the hoist unless it is rigged to pull in a straight line from hook to hook, and the frame is free to swivel on the upper hook. Refer to Figure 2.
14. When there is a load on the hoist, **do not pull or turn the free chaining knob**. Doing this will allow the load to be released in a sudden and uncontrolled manner and may cause injury to you and/or property damage.
15. Never operate the hoist when flammable materials or vapors are present. Contact between metal parts may produce sparks that can cause a fire or explosion.
16. **STAY ALERT!** Watch what you are doing and use common sense. Do not use the hoist when you are tired, distracted or under the influence of drugs, alcohol or medication causing diminished control.

**INSPECTION AND MAINTENANCE**

**INSPECTION**

To maintain continuous and satisfactory operation, a regular inspection procedure must be initiated so that worn or damaged parts can be replaced before they become unsafe. The intervals of inspection must be determined by the individual application and are based upon the type of service to which the hoist is subjected. The intervals indicated below are based on normal service.

The inspections are divided into two general classifications designated as "frequent" and "periodic".

**Frequent Inspections**

These inspections are usually visual examinations by the operator. Frequent inspections are to be performed daily or before each use and they are to include:

- a. Braking mechanism for evidence of slippage.
- b. Operation of the directional lever for free movement.
- 5 c. Load chain for lubricant, wear, damaged links or foreign material.

- d. Hooks for damage, cracks, twists, latch engagement and latch operation.

**Periodic Inspections**

These are visual inspections of external and internal conditions by a designated person making records to provide the basis for continuing evaluation of the condition of the tool. The periodic inspection should include those items listed under frequent inspection as well as the following:

- a. Chain for excessive wear or stretch (see page 6) every three months.
- b. Worn, cracked or distorted parts such as lower hook block, upper hook block, upper hook pin, chain guide roller, stripper, side plates, gear cover, gears, bushings, lever, brake cover, free chaining knob, ratchet hub pawl, cam guide, friction hub and lever ratchet hub - every three months.
- c. Inspect for wear on the tip of the pawls, teeth of the ratchet, and pockets of the liftwheel - every three months.

- d. Loose or missing bolts, nuts, pins or rivets - every three months.
- e. Inspect the brake components for worn, glazed or contaminated friction discs and scoring of the friction hub and ratchet. Replace friction washers if contaminated, glazed or if thickness is less than 0.059 in. (1.5 mm) - every three months.
- f. Corroded, stretched or broken pawl springs, ratchet hub pawl spring and pinion spring - every three months.
- g. Hooks - dye penetrant, magnetic particle or other suitable crack detecting inspection should be performed at least once a year, if external conditions indicate there has been unusual usage.
- h. Capacity/Warning label for legibility and retension - every three months.
- i. Load chain end ring in place and properly secured - every three months.

Any deficiency should be corrected before the hoist is returned to service. Also, the external conditions may show the need for more detailed inspection which, in turn, may require the use of nondestructive type testing.

Any parts deemed unserviceable are to be replaced with new parts before the hoist is returned to service. It is very important that the unserviceable parts be destroyed and properly disposed of to prevent their possible future use as a repair item.

When the unit is subjected to heavy usage or dusty, gritty moist or corrosive atmospheric conditions, shorter time periods must be assigned. Inspection must be made of all parts for unusual wear, corrosion or damage, in addition to those specifically mentioned in the schedule.

**HOOK INSPECTION**

Hooks damaged from chemicals, deformations or cracks, or that have more than a 10° twist from the plane of the unbent hook or excessive opening or seat wear, must be replaced. Also, hooks that are opened to the extent that the latch does not engage the tip must be replaced. See Figure 3.

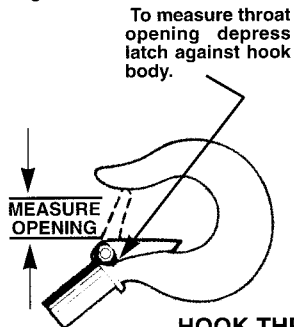

**HOOK THROAT OPENING**

Figure 3. Hook Inspection

Any hook that is twisted or has excessive throat opening indicates abuse or overloading of the hoist. Other load sustaining parts should be inspected for damage.

Check to assure the latch is not damaged or bent and that it operates properly. It should have sufficient spring pressure to keep it tightly against the tip of the hook and allow it to spring back to the tip when released. If the latch does not operate properly, replace it.

The chart of Figure 3 should be used to determine when the hook must be replaced.

**LOAD CHAIN**

**Cleaning and Inspection**

First clean the load chain with a non-acid, non-caustic type solvent, as exposure to some solvents may damage the chain. Slack the chain and make a link-by-link inspection for nicks, gouges, twisted links and excessive wear or stretching. Severely nicked, gouged, twisted worn or stretched chain should be replaced.

To determine if the chain is worn or stretched beyond serviceable limits, check the gage length as indicated in Figure 4. When measuring the gage length, the chain should be clean, free of twists and pulled taut. If the gage length exceeds the maximum length allowed listed in Figure 4, it must be replaced.

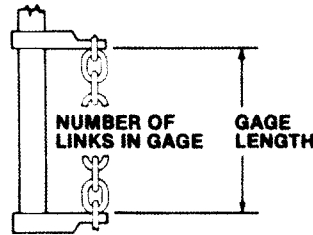

Hoist Capacity (Tons)	Dia. of Chain Stock	No. of Link To Gage	Max. Length Allowable. Used Chain
¾	.236 in.(6mm)	11	8-1½ in.(212.0mm)
1-½	.281 in.(7mm)	11	9-2½ in.(246.9mm)
3 & 6	.394 in.(10mm)	11	13-2½ in.(353.2mm)

Figure 4. Gaging Chain Wear



**WARNING**

USING OTHER THAN CM SUPPLIED LOAD CHAIN MAY CAUSE THE CHAIN TO JAM IN THE HOIST AND/OR ALLOW THE CHAIN TO BREAK AND THE LOAD TO DROP.

**TO AVOID INJURY:**

DUE TO SIZE REQUIREMENTS AND PHYSICAL PROPERTIES, USE ONLY HOISTALOY LOAD CHAIN IN THE SERIES 637 LEVER HOIST.

*Also, these chains are specially heat treated and hardened and should never be repaired.*

**IMPORTANT:** Do not use replaced chain for other purposes such as lifting or pulling. Load chain may break suddenly without visual deformation. For this reason, cut replaced chain into short lengths to prevent use after disposal.

Before returning a chain to service, lubricate liberally with Lubriplate®, Bar and Chain Oil 10-R (Fiske Bros. Refining Co.) or equal lubricant. Remove excess lubricant from the chain by wiping with a cloth.

**LUBRICATION**



**WARNING**

The lubricants used in and recommended for the Series 637 Lever Hoist may contain hazardous materials that mandate specified handling and disposal procedures.

**TO AVOID CONTACT AND CONTAMINATION:**

Handle and dispose of lubricants only as directed in applicable material safety data sheets and in accordance with applicable local, state and federal regulations.

Lubricate the load chain with a light coat of Lubriplate®, Bar and Chain Oil 10-R (Fiske Bros. Refining Co.) or equal lubricant. Be sure the lubricant reaches the bearing surfaces between the links. Remove excess oil from the chain.



**WARNING**

Used motor oils contain known carcinogenic materials.

**TO HEALTH PROBLEMS:**

Never use used motor oils as a chain lubricant. Only use Lubriplate® Bar and Chain Oil 10-R as a lubricant for the load chain.



The Hoist normally requires no additional lubrication except when it has been disassembled for cleaning or repairs.

**The brake is designed to operate dry. Do not use any grease or lubricant on the braking surfaces. When lubricating parts adjacent to the brake, do not use an excessive amount of lubricant which could seep onto the brake surfaces.**

 <b>WARNING</b>
Using any grease or lubricant on the braking surfaces will cause brake slippage and loss of load control which may result in injury and/or property damage.
<b>TO AVOID INJURY:</b>
Do not use any grease or lubricant on braking surfaces. The brake is designed to operate dry.

When the hoist is disassembled for cleaning or repairs, the following locations should be lubricated with approximately one oz. per hoist of Molykote BR-2-S (Dow Corning), Molytex #2 (Texaco) or Topmoly (Topsall) grease or equal lubricant: gears, bearing balls of upper and lower hooks, upper hook pin, rollers of the liftwheel bearing (1-1/2 thru 6 ton units), inside of chain guide roller, exterior of pinion shaft, surface of ratchet hub pawl, surfaces of frame bushings, surface of cam guide and gear cover bushings. Be sure to thoroughly clean the old grease from these parts before re-lubricating.

**To assure extra long life and top performance, be sure to lubricate the various parts of the hoist using the lubricants specified above. If desired, these lubricants can be purchased from CM.**

**DISASSEMBLY AND ASSEMBLY INSTRUCTIONS**

The exploded views and parts list on pages 9 and 10 show the general arrangement and nomenclature of the parts of the Series 637 Lever Hoist. These should be used when disassembling and re-assembling the units so that all parts are properly installed.

**Disassembly**

Four points of caution to be observed upon disassembly of the tool are:

1. Loose rollers are used for the liftwheel bearing on the 1-1/2, 3 and 6 ton units (refer to parts list for number required). Care must be taken so as to not lose or misplace these rollers since they may drop from the unit as the various parts are disassembled.
2. The latch is secured to the hook (upper and lower) by a rivet. To remove the latch, it is necessary to remove the head of the rivet by grinding or drilling. For replacement of the latch, refer to paragraph 4 under assembly instructions.
3. On the 3/4, 1-1/2 and 3 ton units, the upper and lower hook blocks contain loose ball bearings and care must be taken so as to not lose or misplace these upon disassembly. The number of ball bearings in the upper and lower hook blocks are as follows:

Capacity Tons	No. of Bearings Balls
3/4	9
1-1/2	13
3	15

These bearing balls are retained in the upper and lower hook blocks by a set screw that is located under the retainer spring. To expose the set screw, work the spring, one coil at a time, on to or off of the hook body.

Similarly, 17 bearing balls are used to support the lower hook on the 6 ton unit. These are retained in the hook trunnion by a set screw in the end of the trunnion shaft.

4. The pinion shaft and ratchet hub pawl and shaft are under spring pressure and these may fly out of the unit upon disassembly.

**Assembly:**

Consideration must be given to the following when assembling the unit:

1. Assemble the brake components as shown in Figure 5. The ratchet teeth must face as shown and engage the pawls.

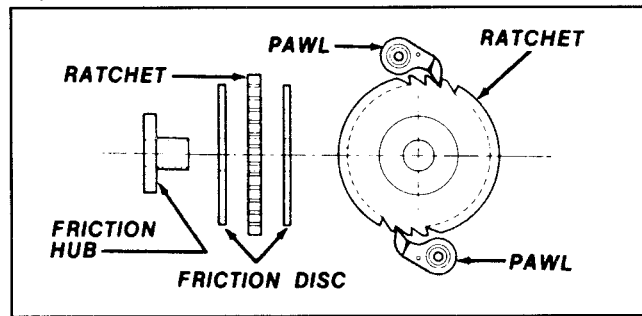

Figure 5. Brake Component Assembly

On the lever, set the directional lever in the neutral ("N") position. Making sure that the friction disc is centered on the friction hub, thread the friction hub into the lever ratchet hub in the lever assembly and firmly hand tighten. Assemble the cam guide (with the "ears" projecting away from the lever) onto the splined portion of the friction hub so that the cam guide fits into one of the three recessed portions of the lever ratchet hub and so the clearance at "A" is slightly smaller than the clearance at "B". Refer to Figure 6.

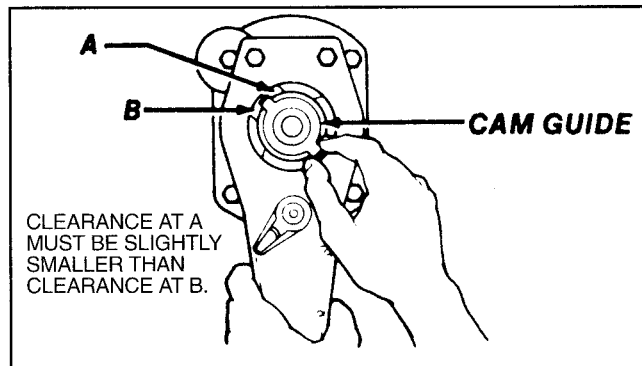

Figure 6. Cam Guide Installation

**The friction hub must be firmly tightened into the lever ratchet hub before the cam guide is set.**

**If the clearance at "A" is extremely small, the tool will be hard to operate in the unload direction. If the clearance at "B" is extremely small the brake will slip and the tool will not hold the load in suspension.**

After making sure that the cam guide is properly assembled to the lever ratchet hub, spring back the pawls and assemble the brake/lever assembly onto the pinion shaft and then release the pawls so that they engage the teeth of the ratchet. Place the free-chaining knob over the cam guide and secure using the brake nut, washer and pin.

2. For proper operation, 37 (for the 1-1/2 ton unit) or 24 (for the 3 & 6 ton units) rollers must be installed for the liftwheel bearing. Applying grease, Molykote BR-2-S (Dow, Corning Corp.), to the rollers will help hold them in position during assembly.

- To insure proper loading of upper and lower hooks on the 3/4, 1-1/2 and 3 ton tools, the correct number of bearing balls (9 on the 3/4 ton unit, 13 on the 1-1/2 ton unit and 15 on the 3 ton unit) must be installed in the upper and lower hook blocks. On the 6 ton unit, 17 bearing balls must be installed in the lower hook trunnion. Apply grease (Molykote BR-2-S, Dow Corning Corp.) to the bearing balls and feed them into the small hole in the hook block (3/4, 1-1/2 and 3 ton units) or in the end of the trunnion shaft (6 ton unit). To retain the bearing balls and to allow the hook to rotate freely, thread the set screw into the hole and tighten firmly. Then, back off the set screw 1 to 1-1/2 turns. On the 3/4, 1-1/2 and 3 ton units, be sure to replace the retainer spring in the recess provided for same in the hook block.
- When assembling the latch to hook, the end of the rivet must be peened over. When peening over the rivet, only apply enough force to form a head to retain the pin. Excessive force will deform the latch and make the latch inoperable.
- Gearing: When assembling the gears, they must be orientated with the timing marks aligned as shown in Figure 7.

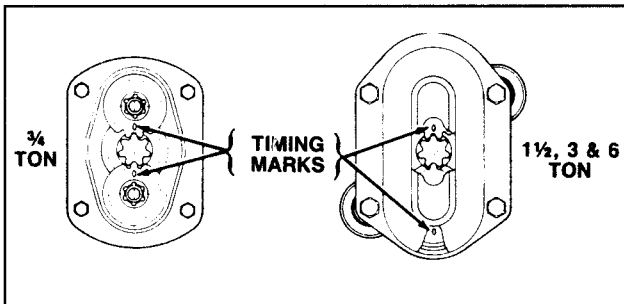

Figure 7. Gear Timing Marks

### Reeving 3/4, 1-1/2 And 3 Ton Units

To install a new length of load chain, it is necessary to disengage the old chain from the lower hook block. To do this, work the retainer spring, one coil at a time, on to or off of the hook body. Remove the chain pin to allow the hook block to be removed from the chain. Arrange the tool for free chaining (see page 4) and pull the old chain through the unit. Disengage the free chaining feature and then set the directional lever to neutral (N). Start an upstanding link of the replacement load chain into the hook side of the tool and between the chain guide roller and the liftwheel with the weld side of the upstanding links facing away from the liftwheel. Refer to Figure 8.

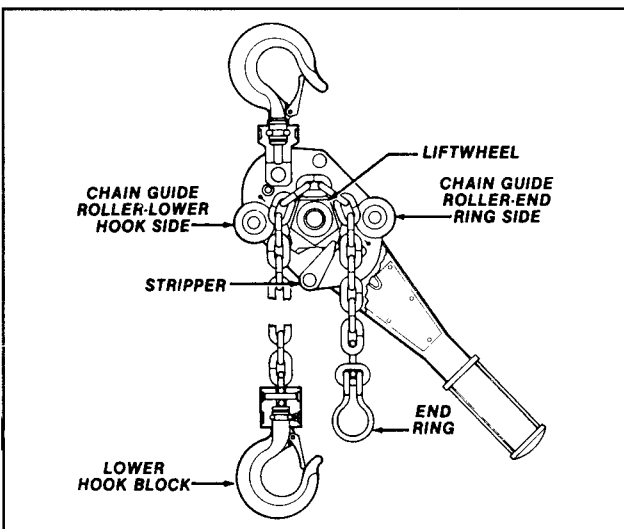

Figure 8. Reeving-3/4, 1-1/2 and 3 Ton

Continue to feed the chain in to the hoist while turning the free chaining knob clockwise. Be sure to guide the chain between the liftwheel and chain guide roller on the end ring side of the tool as shown in Figure 8. Continue to rotate the free chaining knob and pull on the loose end of the chain until a convenient length of chain has been passed through the unit. Assemble the end ring to the free end of the chain by rotating the last link 1/4 turn and passing the ends of the ring through the link as shown in Figure 8. Hammer the ends of the ring together to secure it to the chain. Insert the last link of chain on the hook block side of the tool into the recess on top of the hook block. To secure the chain, slide the chain pin through the hook block and the last link of chain. Slide the retainer spring up the hook block until it snaps into the recess for same, to secure the chain pin.

### 6 Ton Unit

To install a new length of load chain, it is necessary to disengage the old chain from the upper hook hanger by removing the dead end bolt, nut and cotter pin. Then pull the old chain through the lower hook block. Arrange the tool for free chaining (see page 4) and pull the old chain through the unit. Disengage the free chaining feature and then set the directional lever to neutral (N). Make sure that the new, replacement chain has an odd number of links. Start an upstanding link of the replacement load chain into the hook side of the unit and between the chain guide roller and liftwheel, with the weld side of the upstanding links facing away from the liftwheel. Refer to Figure 9.

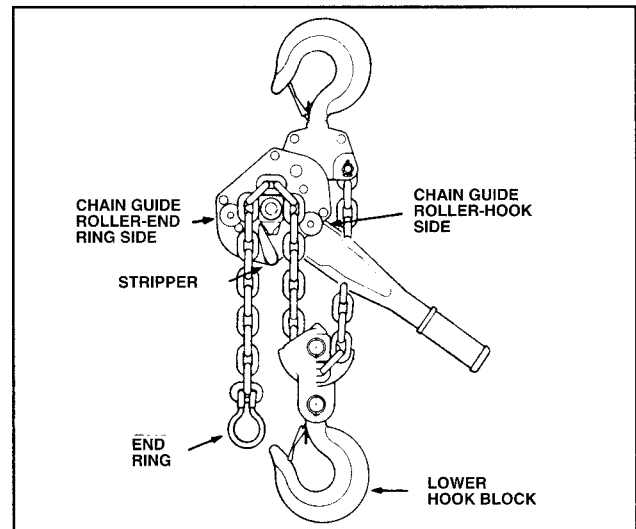

Figure 9. Reeving - 6 Ton

Feed the chain into the hoist while rotating the free chaining knob clockwise. Be sure to guide the chain between the liftwheel and the chain guide roller on the end ring side of the tool as shown in Figure 9. Continue to rotate the free chaining knob and pull on the loose end of the chain until a convenient length of chain has passed through the unit. Assemble the end ring to the loose end of the chain by rotating the last link 1/4 turn and passing the ends of the ring through the link as shown in Figure 9. Hammer the ends of the ring together to secure it to the chain. Place the hoist in a vertical position by supporting it from the upper hook. Remove any twists from the chain and feed it through the lower hook block and around the lower sheave. Making sure there are no twists in the chain, attach the last link of the chain to the hanger using the dead end bolt, nut and cotter pin.



## WARNING

Failure to properly install the load chain between chain guide rollers and liftwheel may cause the chain to lift out of the liftwheel pockets and allow the load to drop.

### TO AVOID INJURY:

Feed load chain between liftwheel and chain guide, as shown in Figures 8 & 9.

### RECOMMENDED SPARE PARTS

To insure continued operation, it is recommended that two friction washers (Key No. 637-12) for each CM Series 637 Lever Hoist in service, be kept on hand at all times to replace friction washers that are worn, contaminated or glazed. See Page 10 for ordering information.

### PREVENTATIVE MAINTENANCE

In addition to the inspection procedures, a preventative maintenance program should be established to prolong the useful life of the hoist and maintain its dependability and

continued safe use. The program should include the periodic inspections with particular attention being paid to the lubrication of various components using the recommended lubricants.

### TESTING

Prior to initial use, all altered or repaired hoists or used hoists that have not been operated for the previous 12 months shall be tested by the user for proper operation.

Test the unit first in the unloaded state and then with a light load of 100 pounds(45Kg.) times the number of load supporting parts of load chain to be sure it operates properly and the brake holds the load when the lever is released; then test with a load of 125% of rated capacity.

In addition, hoists in which load sustaining parts have been replaced must be tested with 125% of rated capacity by or under the direction of a designated person and a written report prepared for record purposes.

**NOTE: For additional information on inspection and testing refer to ASME B30.21 "Manually Lever Operated Hoists" obtainable from ASME Order Department, 22 Law Drive, Box 2300, Fairfield, NJ 07007-2300, U.S.A.**

## 3/4, 1-1/2, 3 and 6 Ton Series 637 Lever Hoist Parts List

Key No.	No. Req'd	Part Name	Part Number			
			3/4 Ton	1-1/2 Ton	3 Ton	6 Ton
637-1	1	Side Plate Assembly (Gear Side). Includes 3 Bushings, 4 Studs, Liftwheel and Liftwheel Gear.	37760C	37733C	37794C	37794C
637-2	1	Side Plate Assembly (Brake Side). Includes Bushing and Pawl Studs on 3/4 Ton Unit. Includes Bearing Race and 2 Pawl Assemblies on 1-1/2, 3 and 6 Ton Units.	37761C	37734C	37795C	37795C
637-3	2	Pawl with Spring and Retainer Ring	37762C	-	-	-
637-4	1	Stripper	37763C	37735C	37796C	37796C
637-5	1	Gear Set (Includes 2 Gears)	37764C	37736C	37797C	37797C
637-6	1	Spring with Seat	37765C	37737C	37798C	37798C
637-7	1	Pinion Shaft	37711C	37738C	37799C	37799C
637-8	1	Gear Cover	37712C	37739C	37800C	37800C
637-9	1	Gear Cover Hardware Set. Includes 4 Nuts and 4 Lockwashers.	37713C	37740C	37801C	37801C
637-10	2	Chain Guide Roller	37714C	37741C	37802C	37802C
637-11	1	Friction Hub	37715C	37742C	37803C	37803C
637-12	2	Friction Disc	37716C	37743C	22869	22869
637-13	1	Ratchet	37717C	37744C	37805C	37805C
637-15	1	Brake Cover for 3/4 Ton Unit or Lever Ratchet Hub, Brake Cover and Lever Rear Half Assembled for 1-1/2, 3 and 6 Ton Units.	37718C	37745C	37806C	37806C
637-16	1	Brake Cover Hardware Kit, Includes 4 Nuts and 4 Lockwashers.	37719C	37746C	37807C	37807C
637-17	1	Lever Hardware Kit. Includes 4 Screws and 3 Lockwashers for the 3/4 Ton Unit. Includes 2 Screws, 2 Nuts and 4 Lockwashers for the 1-1/2, 3 and 6 Ton Units.	37720C	37747C	37747C	37747C
637-18	1	Lever Assembly, Front Half includes Directional Lever	37721C	37748C	37748C	37748C
637-19	1	Lever Assembly, Rear Half	37722C	-	-	-
637-20	1	Cam Guide	37723C	37749C	37749C	37749C
637-21	1	Free Chaining Knob	37724C	37750C	37750C	37750C
637-22	1	Lever Ratchet Hub	37725C	-	-	-
637-23	1	Brake Nut, Washer and Cotter Pin	37726C	37751C	37751C	37751C
637-24	1	Ratchet Hub Pawl Kit. Includes Pawl, Spring and Shaft.	37727C	37752C	37752C	37752C
637-25	1	Lever Grip	37728C	37753C	37753C	37753C
637-26	1	Upper Hook Assembly. Includes Hook, Latch, Bearing Balls, Set Screw, Retainer Spring and Hook Block for 3/4, 1-1/2 and 3 Ton Units. Includes Hook, Latch, Hanger, Dead End Bolt, Nut and Cotter Pin for 6 Ton Unit.	37729C	37754C	37815C	37820C
637-27	1	Upper Hook Pin	37730C	37755C	37816C	37816C
637-28	1	Lower Hook Assembly. Includes Hook, Latch, Bearing Balls, Set Screw, 2 Retainer Springs, Chain Pin and Hook Block for 3/4, 1-1/2 and 3 Ton Units. Includes Hook, Latch, Bearing Balls, Set Screw, 4 Retaining Rings, Sheave, Rollers, Sheave Shaft and Hook Block for 6 Ton Unit.	37731C	37756C	37817C	37821C
637-29	2	Hook Latch Kit	37732C	37757C	37818C	37822C
637-30	1	Load Chain End Ring	40471	40471	37823	37823
637-31	1	Load Chain, Specify Length Required.	85959	85961	85960	85960
637-32	1	Capacity/Warning Label	37701C	37702C	37782C	37783C
637-33	1	Bearing Kit. Includes 37 Rollers and Inner Ring for 1-1/2 Ton Unit. Includes 24 Rollers and Inner Ring for 3 and 6 Ton Units.	-	37758C	37819C	37819C

**ORDERING INFORMATION:** When corresponding or ordering repair parts always provide: 1) Hoist Capacity and 2) Serial Number (Stamped on Capacity/Warning Label.) For parts orders also specify: Key Number of part, part name and number, and quantity desired. When ordering parts consider replacing bearings, fasteners, etc. that may be damaged or lost during disassembly or have deteriorated because of age or service. Parts should be ordered from CM's Master Parts Depots. To locate the Master Parts Depot nearest you, call (800) 888-0985 or Fax (716) 689-5544.

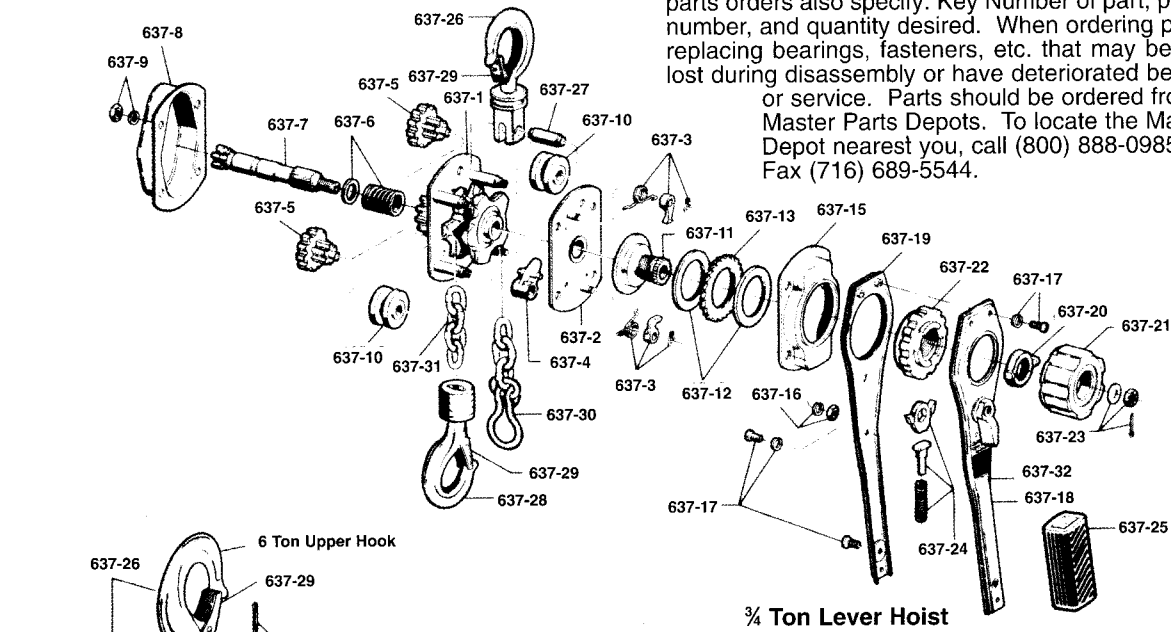

**! WARNING**

USING "COMMERCIAL" OR OTHER MANUFACTURER'S PARTS TO REPAIR THE SERIES 637 LEVER HOIST MAY CAUSE LOAD LOSS.

**TO AVOID INJURY:**

USE ONLY CM SUPPLIED REPLACEMENT PARTS. PARTS MAY LOOK ALIKE BUT CM PARTS ARE MADE OF SPECIFIC MATERIALS OR PROCESSED TO ACHIEVE SPECIFIC PROPERTIES.

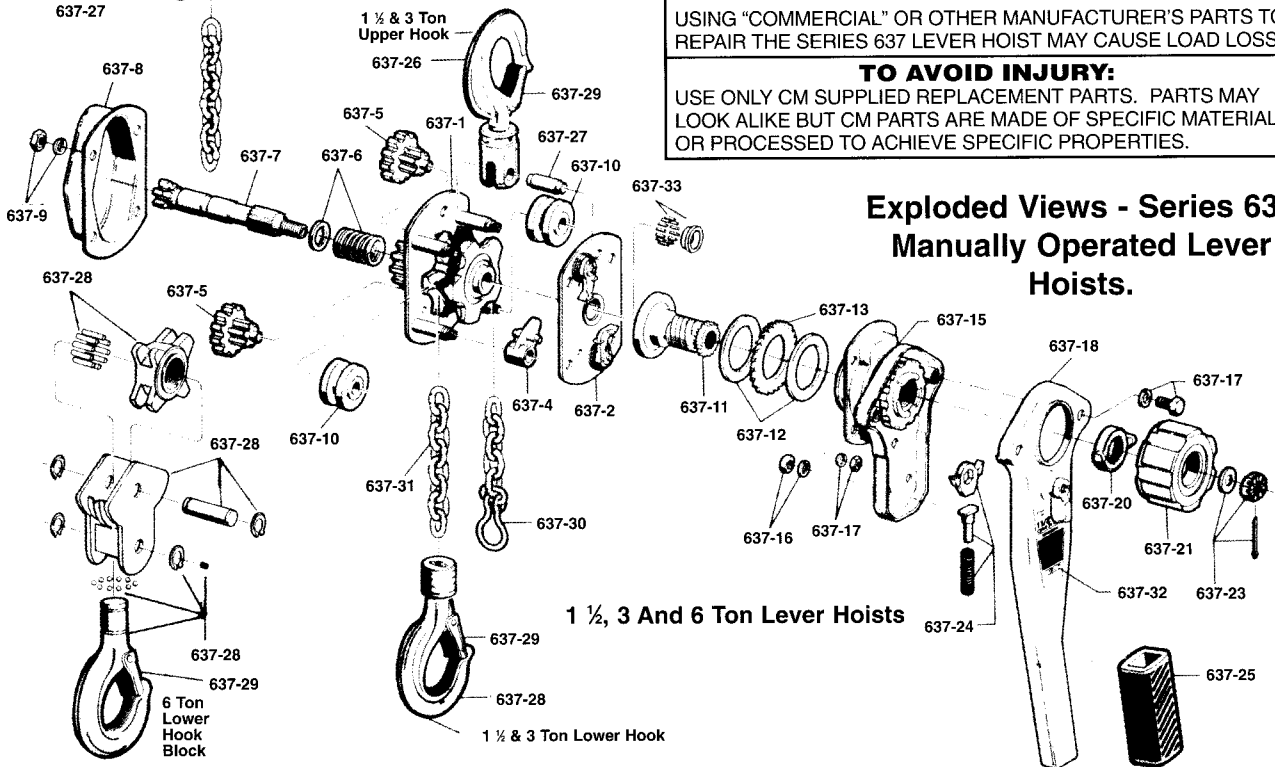

**Exploded Views - Series 637  
Manually Operated Lever  
Hoists.**

<b>PART NUMBERS FOR PACKAGED LUBRICANTS Used in the CM Series 637 Lever Hoist (Refer to page 6 for Lubrication Instructions)</b>		
Lubricant Usage	Type of Lubricant	Part Numbers and Packaged Quantities of Lubricants
Gears, Rollers of Liftwheel and Gear Bearings	Grease (Molykote BR-2-S or Equal)	28606 - 1/2 lb. (.23Kg.) can 28618 - 1 lb. (.46Kg.) can
Pawl Stud	Oil (WD-40 or Equal)	Obtain locally—not stocked by CM
Load Chain	Oil (Lubriplate Bar and Chain Oil 10-R or Equal)	28608 - 1 pint (.5L) can 28619 - 1 gal.(3.8L) can

Note: When ordering parts, always furnish rated load and serial number of hoist on which the parts are to be used.

For the location of the nearest CM Master Parts Depot, call (800) 888-0985 or FAX (716) 689-5644.

## LIMITATION OF WARRANTIES, REMEDIES AND DAMAGES

THE WARRANTY STATED BELOW IS GIVEN IN PLACE OF ALL OTHER WARRANTIES, EXPRESS OR IMPLIED, OF MERCHANTABILITY, FITNESS FOR A PARTICULAR PURPOSE, OR OTHERWISE, NO PROMISE OR AFFIRMATION OF FACT MADE BY ANY AGENT OR REPRESENTATIVE OF SELLER SHALL CONSTITUTE A WARRANTY BY SELLER OR GIVE RISE TO ANY LIABILITY OR OBLIGATION.

Seller warrants that on the date of delivery to carrier the goods are free from defects in workmanship and materials.

SELLER'S SOLE OBLIGATION IN THE EVENT OF BREACH OF WARRANTY OR CONTRACT OR FOR NEGLIGENCE OR OTHERWISE WITH RESPECT TO GOODS SOLD SHALL BE EXCLUSIVELY LIMITED TO REPAIR OR REPLACEMENT, F.O.B. SELLER'S POINT OF SHIPMENT, OF ANY PARTS WHICH SELLER DETERMINES TO HAVE BEEN DEFECTIVE or if Seller determines that such repair or replacement is not feasible, to a refund of the purchase price upon return of the goods to Seller.

Any action against Seller for breach of warranty, negligence or otherwise, must be commenced within one year after such cause of action accrues.

NO CLAIM AGAINST SELLER FOR ANY DEFECT IN THE GOODS SHALL BE VALID OR ENFORCEABLE UNLESS BUYER'S WRITTEN NOTICE THEREOF IS RECEIVED BY SELLER WITHIN ONE YEAR FROM THE DATE OF SHIPMENT. Seller shall not be liable for any damage, injury or loss arising out of the use of the goods if, prior to such damage, injury or loss, such goods are (1) damaged or misused following Seller's delivery to carrier; (2) not maintained, inspected, or used in compliance with applicable law and Seller's written instructions and recommendations; or (3) installed, repaired,

altered or modified without compliance with such law, instructions or recommendations.

UNDER NO CIRCUMSTANCES SHALL SELLER BE LIABLE FOR INCIDENTAL OR CONSEQUENTIAL DAMAGES AS THOSE TERMS ARE DEFINED IN SECTION 2-715 OF THE UNIFORM COMMERCIAL CODE.

### INDEMNIFICATION AND SAFE OPERATION

Buyer shall comply with and require its employees to comply with directions set forth in instructions and manuals furnished by Seller and shall use and require its employees to follow such instructions and manuals and to use reasonable care in the use and maintenance of the goods. Buyer shall not remove or permit anyone to remove any warning or instruction signs on the goods. In the event of personal injury or damage to property or business arising from the use of the goods, Buyer shall within 48 hours thereafter give Seller written notice of such injury or damage. Buyer shall cooperate with Seller in investigating any such injury or damage and in the defense of any claims arising therefrom.

If Buyer fails to comply with this section or if any injury or damage is caused, in whole or in part, by Buyer's failure to comply with applicable federal or state safety requirements, Buyer shall indemnify and hold Seller harmless against any claims, loss or expense for injury or damage arising from the use of the goods.



## WARNING

ALTERATIONS OR MODIFICATIONS OF EQUIPMENT AND USE OF NON-CM REPAIR PARTS CAN LEAD TO DANGEROUS OPERATION AND INJURY.

### TO AVOID INJURY:

- DO NOT ALTER OR MODIFY EQUIPMENT
- DO USE ONLY CM PROVIDED REPLACEMENT PARTS.



Columbus McKinnon Corporation • Industrial Products Division • 140 John James Audubon Parkway  
Amherst, New York 14228-1197 • 1-800-888-0985 • Fax 716-689-5644